



ANCHOR 410-1



Grade 2 padlock manufactured in all rust resistant materials. Suitable for locking cash boxes, tool boxes, lockers, power station switches and the like. The padlock is equipped with a 5-pin key system and 2 keys. The padlock is available in key differ (std) and keyed alike.

ANCHOR 5-Pin cylinder 410

- > ANCHOR 5-Pin cylinder with 2.650 different key combinations.
- > Spool pins and asymmetric key profile to prevent picking.
- > Double ball blocking to prevent the lock from being picked with shims.
- > Stainless steel shackle and internal components in corrosive resistant materials makes the padlock ideal even in demanding applications like outdoor environments and swimming areas.



- > Padlock body: 40mm brass
- > Shackle: 6mm stainless steel
- > Plating: Brass
- > Cylinder type: 5-Pin cylinder
- > Shackle heights: 24mm
- > Certification: Class 1 according to SSF 014 rev 3.
Grade 2 according to EN 12320:2012
- > Options: Carded (CARDED)
Keyed Alike (KA)
Twin package (TW CARDED)

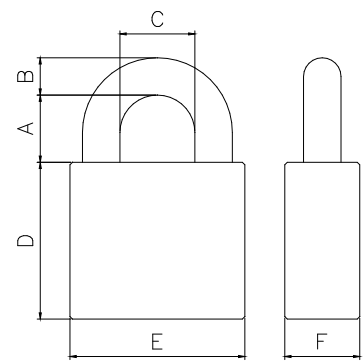

A	B	C	D	E	F
24	6	19	35	40	14

